



## **TW3001AR Active Receiver**



**Single Channel for UTP Transmission**

**C1666M-A (4/06)**



# Important Safety Instructions

---

1. Read these instructions.
2. Keep these instructions.
3. Heed all warnings.
4. Follow all instructions.
5. Do not use this apparatus near water.
6. Clean only with dry cloth.
7. Do not block any ventilation openings. Install in accordance with the manufacturer's instructions.
8. Do not install near any heat sources such as radiators, heat registers, stoves, or other apparatus (including amplifiers) that produce heat.
9. Do not defeat the safety purpose of the polarized or grounding-type plug. A polarized plug has two blades with one wider than the other. A grounding plug has two blades and a third grounding prong. The wide blade or the third prong are provided for your safety. If the provided plug does not fit into your outlet consult an electrician for replacement of the obsolete outlet.
10. Protect the power cord from being walked on or pinched particularly at plugs, convenience receptacles, and the points where they exit from the apparatus.
11. Only use attachments/accessories specified by the manufacturer.
12. Use only with the cart, stand, tripod, bracket, or table specified by the manufacturer, or sold with the apparatus. When a cart is used, use caution when moving the cart/apparatus combination to avoid injury from tip-over.
13. Refer all servicing to qualified service personnel. Servicing is required when the apparatus has been damaged in any way, such as power-supply cord or plug is damaged, liquid has been spilled or objects have fallen into the apparatus, the apparatus has been exposed to rain or moisture, does not operate normally, or has been dropped.
14. Apparatus shall not be exposed to dripping or splashing and that no objects filled with liquids, such as vases shall be placed on the apparatus.
15. **WARNING:** To reduce the risk of fire or electric shock, do not expose this apparatus to rain or moisture.
16. Installation should be done only by qualified personnel and conform to all local codes.
17. Unless the unit is specifically marked as a NEMA Type 3, 3R, 3S, 4, 4X, 6, or 6P enclosure, it is designed for indoor use only and it must not be installed where exposed to rain and moisture.
18. Use only installation methods and materials capable of supporting four times the maximum specified load.
19. A CCC-approved power cord must be used to power this equipment when used in China.

# Regulatory Notices

---

This device complies with Part 15 of the FCC Rules. Operation is subject to the following two conditions: (1) this device may not cause harmful interference, and (2) this device must accept any interference received, including interference that may cause undesired operation.

## RADIO AND TELEVISION INTERFERENCE

This equipment has been tested and found to comply with the limits of a Class A digital device, pursuant to Part 15 of the FCC rules. These limits are designed to provide reasonable protection against harmful interference when the equipment is operated in a commercial environment. This equipment generates, uses, and can radiate radio frequency energy and, if not installed and used in accordance with the instruction manual, may cause harmful interference to radio communications. Operation of this equipment in a residential area is likely to cause harmful interference in which case the user will be required to correct the interference at his own expense.

Changes and Modifications not expressly approved by the manufacturer or registrant of this equipment can void your authority to operate this equipment under Federal Communications Commission's rules.

In order to maintain compliance with FCC regulations shielded cables must be used with this equipment. Operation with non-approved equipment or unshielded cables is likely to result in interference to radio and television reception.

This Class A digital apparatus complies with Canadian ICES-003.

Cet appareil numérique de la classe A est conforme à la norme NMB-003 du Canada.

 Green The materials used in the manufacture of this document and its components are compliant to the requirements of Directive 2002/95/EC.



This equipment contains electrical or electronic components that must be recycled properly to comply with Directive 2002/96/EC of the European Union regarding the disposal of waste electrical and electronic equipment (WEEE). Contact your local dealer for procedures for recycling this equipment.

# Description

---

The TW3001AR is a single-channel active receiver that can receive live video over unshielded twisted pair (UTP) cable.

The adaptive technology in the TW3001AR automatically adjusts the low, medium and high frequency components of the video signal allowing for the best possible video transmission. The adaptive technology eliminates the need for manual adjustment by automatically adjusting to provide the most favorable video transmission depending on cable length needed. The unit has been optimized for use with Cat5e and Cat6 cable, although Cat3 and Cat5 cable can be used for shorter distances.

The DIP switch on the bottom of the TW3001AR allows you to override the adaptive technology and manually select the cable distance. Switches 1, 2, 3, and 4 can be set to 4,000 feet (1,219 meters), 3,000 feet (914 meters), 2,000 feet (610 meters), and 1,000 feet (305 meters), respectively. Switch 5 can be set to high mode and low mode.

There are two ways to power the TW3001AR. You can power it by installing it into an RK5000PS-3U using the 4-pin connector. For stand-alone power, you can use the 2-pin power connector and use either a 12 VDC power supply (supplied) or a 24 VAC power supply.

The following features are found on the TW3001AR:

- Full motion color/black-white video up to 4,000 feet (1,219 meters) with Cat5e or Cat6
- Supports Coaxitron® control (PTZ control signals) up to 750 feet (229 meters)
- Compatible with all Pelco twisted pair equipped cameras, enclosures, and domes
- Built-in surge suppression
- Easy termination with removable UTP connector
- Supports NTSC, PAL, and SECAM
- Can be mounted into a Pelco fiber rack, wall mount base kit, or wall clip

## PARTS OF THE RECEIVER

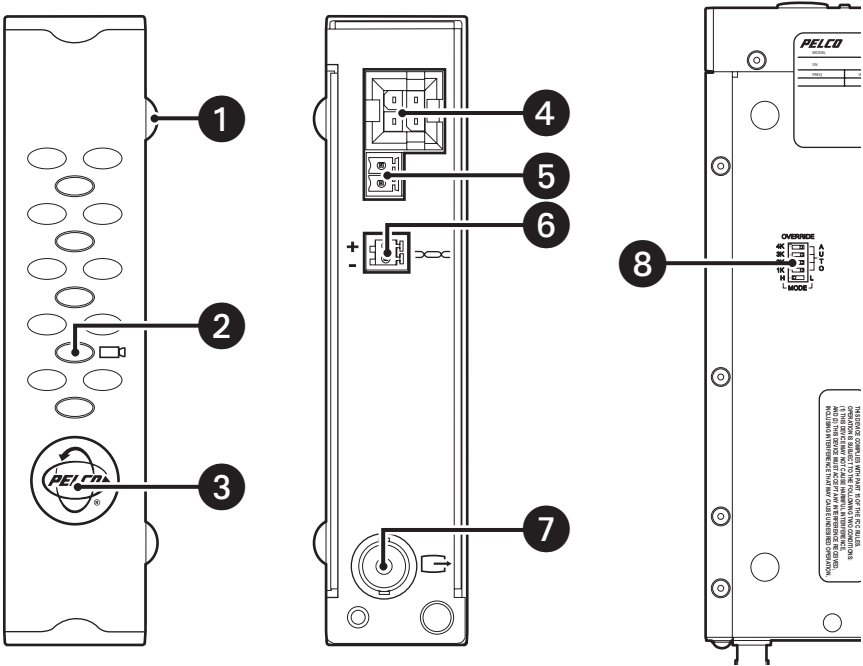

Figure 1. TW3001AR Parts

- 1 **Rubber Feet (4):** For placing unit on a flat surface, such as a desk or shelf.
- 2 **Status LED:** Lights red when there is no UTP video being received. Lights green when there is UTP video being received. Flashes amber when Coaxitron pan/tilt/zoom (PTZ) control commands are being received.
- 3 **Pelco Badge:** Lights blue to indicate power when using either the 4-pin rack power connector or the 2-pin power connector.
- 4 **Rack Power Connector:** 4-pin, power from RK5000PS-3U.
- 5 **Power Connector (3.5 mm):** 2-pin; stand-alone power, 12 VDC or 24 VAC.
- 6 **UTP Connector (2.5 mm):** 2-pin connector with removable mating connector.
- 7 **BNC Connector:** Coaxial output.
- 8 **DIP Switch:** Override the adaptive technology with the manual selection of cable distance (1,000 to 4,000 feet or 305 to 1,219 meters). Switch 5 is used for selecting high mode or low mode.

# Installation

---

Make sure all parts are present for the unit.

- 1 Universal power supply (Part #PS04-1502-0512G)
- 1 Wall clip
- 1 2-pin power connector
- 1 2-pin UTP connector

## MOUNTING

The TW3001AR receiver is 3 rack units high and can be mounted into a fiber rack, onto a wall using a fiber wall mount kit or into the supplied wall clip.

### USING A RACK

You can mount a TW3001AR into either an RK5000PS-3U (for power) or an RK5000-3U. For additional mounting information, refer to the RK5000PS-3U/RK5000-3U Fiber Rack Mount Chassis Installation manual.

### USING WALL MOUNT KITS

The optional WM5001-3U wall mount base kit allows attachment of a single TW3001AR to a wall. Up to two WM5001-3UEXP wall mount expansion kits can be used to allow attachment of two additional receivers to the wall. For additional information, refer to the Fiber Wall Mount Kits Installation manual.

## USING A WALL CLIP

To attach the TW3001AR receiver to a wall using the supplied wall clip, refer to Figure 2 and do the following:

1. Attach the wall clip to a wall using two screws (not supplied).
2. Slide the receiver into the clip until the two holes on the bottom of the receiver align with the two holes on the lower flange of the clip.
3. Attach the receiver to the clip using the two Phillips pan head screws provided with the clip.

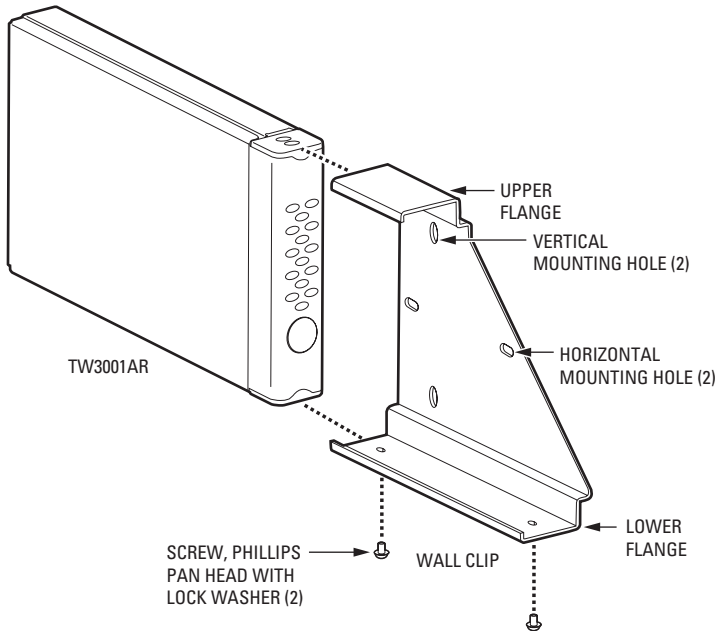
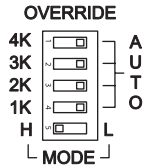

**Figure 2.** Mounting the TW3001AR Using the Wall Clip



## SETTING THE DIP SWITCHES

You can override the adaptive technology by manually adjusting switches 1 through 4 on the DIP Switch. The factory default switch positions are shown in Figure 3. Switches 1 through 4 are set to AUTO and Switch 5 is set to H MODE (high mode).



**Figure 3.** Default Switch Positions

If you want to transmit video over 4,000 feet (1,219 meters) of UTP cable, set switch 1 to 4K. Set switch 2 to 3K if you want a distance of 3,000 feet (914 meters), switch 3 to 2K if you want a distance of 2,000 feet (610 meters), and switch 4 to 1K if you want a distance of 1,000 feet (305 meters). You can set only one distance at a time.

With switch 5 you can select H (high) or L (low). High mode is the default position and is used when video is 1Vp-p. Low mode is used when video is less than 1Vp-p.

## APPLICATIONS

You can connect the TW3001AR active receiver to transmitters, such as the TW3001P passive transceiver and the TW3001AT active transmitter, and to Pelco UTP cameras, such as the CC3710/CC3610 Series. Although you can connect these products using an unshielded twisted pair Cat3 and Cat5 cable, Cat5e and Cat6 are recommended for the best video performance.

Always connect the UTP wires on the Cat cable from + to + and from - to -. For example, if you connect the blue wire to the + on the TW3001AR make sure you connect the other end of the blue wire to the + on the transmitter.

Table A shows the maximum cable distance with Coaxitron or video only when connecting the TW3001AR to a TW3001P passive transceiver with a particular type of Cat cable.

**Table A.** Cable Distance with TW3001P

<b>Cable Type</b>	<b>Maximum Distance (with Coaxitron)</b>	<b>Maximum Distance (video only)</b>
Cat3	750 ft (229 m)	1,500 ft (457 m)
Cat5	750 ft (229 m)	3,000 ft (914 m)
Cat5e	750 ft (229 m)	4,000 ft (1,219 m)
Cat6	750 ft (229 m)	4,000 ft (1,219 m)

**NOTE:** Cat5e cable is recommended for the best video performance.

Table B shows the minimum size for a single wire and stranded wire.

**Table B.** Wire Gauge

<b>Wire Gauge (minimum size)</b>	
Single Wire (solid)	24 AWG (0.25 mm <sup>2</sup> )
Stranded Wire (flexible)	24 AWG (1.0 mm <sup>2</sup> )

Figure 4 shows a TW3001AR connected to a UTP Camclosure®.

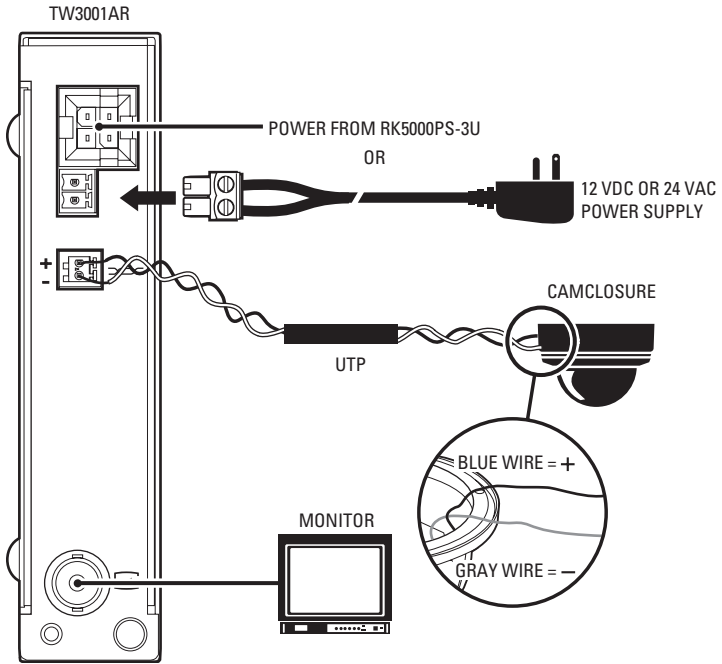

**Figure 4.** TW3001AR Connected to a UTP Camclosure

Figure 5 shows a TW3001AR connected to a UTP fixed camera.

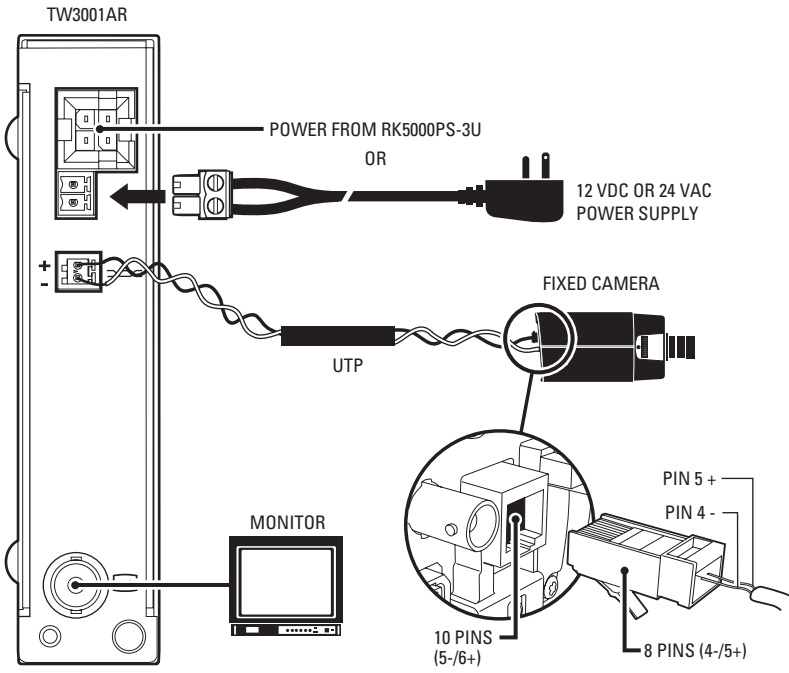

**Figure 5.** TW3001AR Connected to a UTP Fixed Camera

Figure 6 shows a TW3001AR connected to a UTP Spectra® Dome for Coaxitron PTZ control.

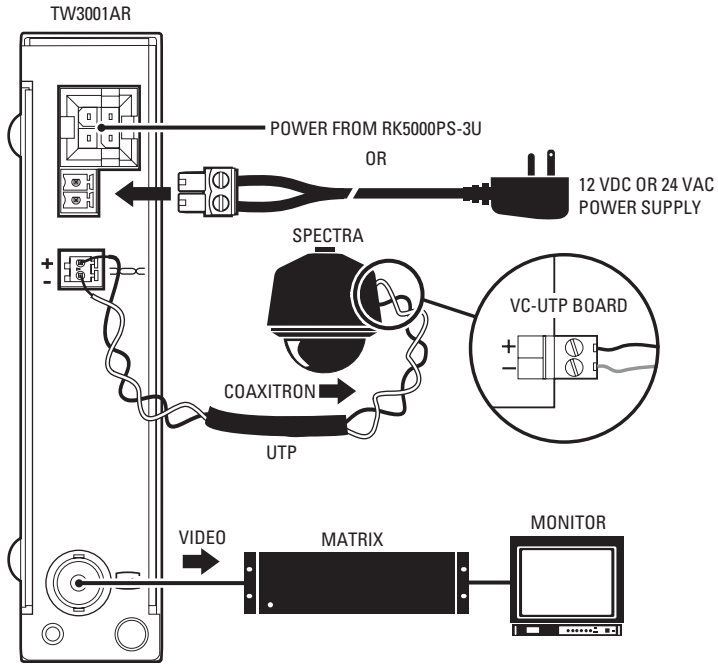

**Figure 6.** TW3001AR Connected to a Spectra Dome

Figure 7 shows a TW3001AR connected to a TW3001P passive transceiver. The TW3001P then connects to a non-UTP fixed camera.

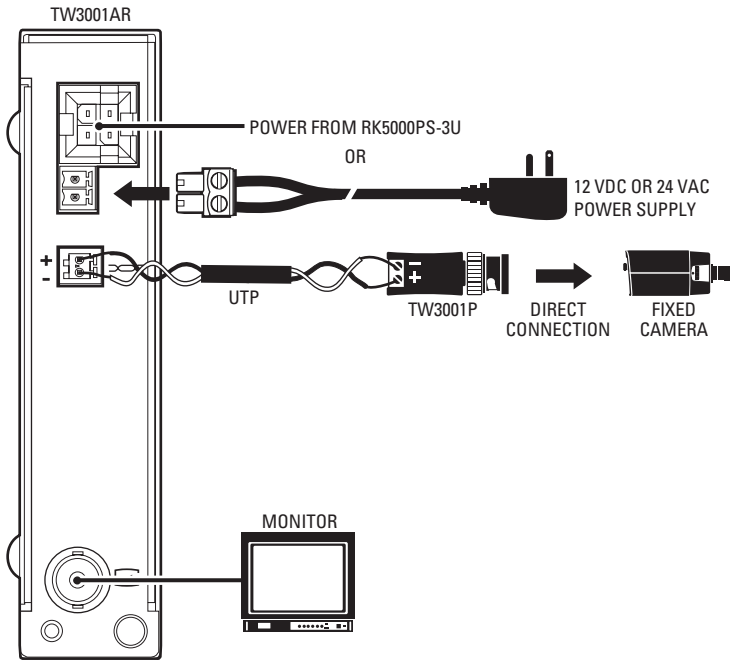

**Figure 7.** TW3001AR Connected to a Single Passive Transceiver

Figure 8 shows a TW3001AR connected to a TW3032P passive transceiver.

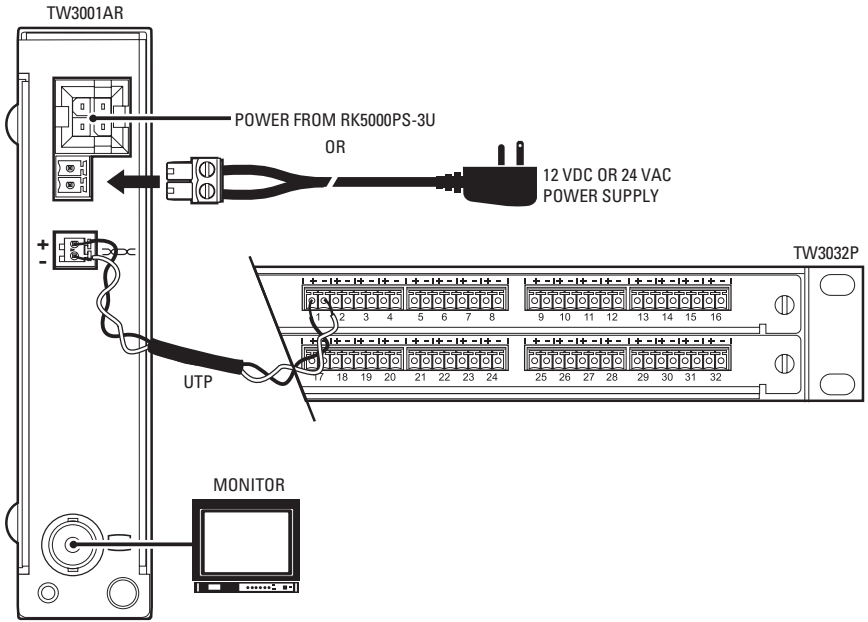

**Figure 8.** TW3001AR Connected to a 32-Channel Passive Transceiver

Figure 9 shows a TW3001AR connected to a TW3004P passive transceiver. The TW3004P then connects to a non-UTP fixed camera.

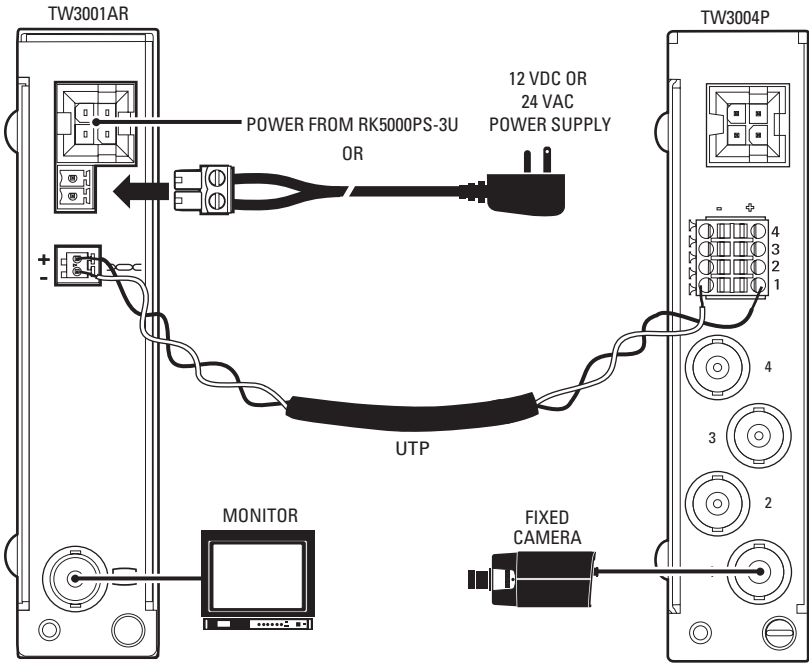

**Figure 9.** TW3001AR Connected to a 4-Channel Passive Transceiver



# Specifications

---

## ELECTRICAL

Input Voltage	12 VDC or 24 VAC, 50-60Hz
Power Consumption	2.5 W
Wire Type	Unshielded twisted pair (24 AWG maximum)
Wire Category	Cat3 or better
DC Loop Resistance	52 ohms per 1,000 feet
Differential Capacitance	19pF/ft max
Transient Immunity	300 W peak pulse power (8/20 US)

## VIDEO CHARACTERISTICS

Video Output	1, BNC
Format	NTSC, PAL, SECAM
Frequency Response	DC to MHz
Common Mode/Differential Mode Rejection	>70 dB

## MECHANICAL

Connectors	
BNC	Video output
4-Pin Connector	Rack power
2-Pin Connector (2.5 mm)	UTP input/output
2-Pin Connector (3.5 mm)	Power
Construction	Steel
Finish	Silver

## GENERAL

Operating Temperature	32° to 167°F (0° to 75°C)
Relative Humidity	0 to 90%, noncondensing
Data Transmission	Supports Coaxitron up to 750 feet
LED Indicators	Pelco badge (blue); status LED (red, green, flashing amber)
Dimensions	8.75" D x 1.08" W x 4.81" H (22.23 x 2.74 x 12.22 cm)
Unit Weight	1.0 lb (0.45 kg)



# PRODUCT WARRANTY AND RETURN INFORMATION

## WARRANTY

Pelco will repair or replace, without charge, any merchandise proved defective in material or workmanship **for a period of one year** after the date of shipment.

Exceptions to this warranty are as noted below:

- Five years on FR/FT/FS Series fiber optic products and TW3000 Series unshielded twisted pair transmission products.
- Three years on Spectra® IV products.
- Three years on Genex® Series products (multiplexers, server, and keyboard).
- Three years on Camclosure® and fixed camera models, except the CC3701H-2, CC3701H-2X, CC3751H-2, CC3651H-2X, MC3651H-2, and MC3651H-2X camera models, which have a five-year warranty.
- Three years on PMCL200/300/400 Series LCD monitors.
- Two years on standard motorized or fixed focal length lenses.
- Two years on Legacy®, CM6700/CM6800/CM9700 Series matrix, and DF5/DF8 Series fixed dome products.
- Two years on Spectra III™, Esprit®, ExSite™, and PS20 scanners, including when used in continuous motion applications.
- Two years on Esprit and WW5700 Series window wiper (excluding wiper blades).
- Two years (except lamp and color wheel) on Digital Light Processing (DLP®) displays. The lamp and color wheel will be covered for a period of 90 days. The air filter is not covered under warranty.
- Eighteen months on DX Series digital video recorders, NVR300 Series network video recorders, and Endura™ Series distributed network-based video products.
- One year (except video heads) on video cassette recorders (VCRs). Video heads will be covered for a period of six months.
- Six months on all pan and tilts, scanners or preset lenses used in continuous motion applications (that is, preset scan, tour and auto scan modes).

Pelco will warrant all replacement parts and repairs for 90 days from the date of Pelco shipment. All goods requiring warranty repair shall be sent freight prepaid to Pelco, Clovis, California. Repairs made necessary by reason of misuse, alteration, normal wear, or accident are not covered under this warranty.

Pelco assumes no risk and shall be subject to no liability for damages or loss resulting from the specific use or application made of the Products. Pelco's liability for any claim, whether based on breach of contract, negligence, infringement of any rights of any party or product liability, relating to the Products shall not exceed the price paid by the Dealer to Pelco for such Products. In no event will Pelco be liable for any special, incidental or consequential damages (including loss of use, loss of profit and claims of third parties) however caused, whether by the negligence of Pelco or otherwise.

The above warranty provides the Dealer with specific legal rights. The Dealer may also have additional rights, which are subject to variation from state to state.

If a warranty repair is required, the Dealer must contact Pelco at (800) 289-9100 or (559) 292-1981 to obtain a Repair Authorization number (RA), and provide the following information:

1. Model and serial number
2. Date of shipment, P.O. number, Sales Order number, or Pelco invoice number
3. Details of the defect or problem

If there is a dispute regarding the warranty of a product which does not fall under the warranty conditions stated above, please include a written explanation with the product when returned.

Method of return shipment shall be the same or equal to the method by which the item was received by Pelco.

## RETURNS

In order to expedite parts returned to the factory for repair or credit, please call the factory at (800) 289-9100 or (559) 292-1981 to obtain an authorization number (CA number if returned for credit, and RA number if returned for repair).

All merchandise returned for credit may be subject to a 20% restocking and refurbishing charge.

Goods returned for repair or credit should be clearly identified with the assigned CA or RA number and freight should be prepaid. Ship to the appropriate address below.

*If you are located within the continental U.S., Alaska, Hawaii or Puerto Rico, send goods to:*

Service Department  
Pelco  
3500 Pelco Way  
Clovis, CA 93612-5699

*If you are located outside the continental U.S., Alaska, Hawaii or Puerto Rico and are instructed to return goods to the USA, you may do one of the following:*

If the goods are to be sent by a COURIER SERVICE, send the goods to:

Pelco  
3500 Pelco Way  
Clovis, CA 93612-5699 USA

If the goods are to be sent by a FREIGHT FORWARDER, send the goods to:

Pelco c/o Expeditors  
473 Eccles Avenue  
South San Francisco, CA 94080 USA  
Phone: 650-737-1700  
Fax: 650-737-0933

## REVISION HISTORY

Manual #	Date	Comments
C1666M	1/06	Original version.
C1666M-A	4/06	Added high mode and low mode information.

Pelco, the Pelco logo, Camclosure, Esprit, Genex, Legacy, Coaxitron, and Spectra are registered trademarks of Pelco.  
Endura and ExSite are trademarks of Pelco.  
DLP is a registered trademark of Texas Instruments, Inc.

©Copyright 2006, Pelco.  
All rights reserved.



Worldwide Headquarters  
3500 Pelco Way  
Clovis, California 93612 USA

USA & Canada  
Tel: 800/289-9100  
Fax: 800/289-9150  
International  
Tel: 1-559/292-1981  
Fax: 1-559/348-1120

[www.pelco.com](http://www.pelco.com)

ISO9001

Australia | Canada | Finland | France | Germany | Italy | Macau | The Netherlands | Russia | Singapore  
South Africa | Spain | Sweden | United Arab Emirates | United Kingdom | United States